

**FORME COSTRUTTIVE CON ALBERI O ALBERI CAVI**  
**CONSTRUCTIVE FORMS WITH SHAFTS OR HOLLOW SHAFTS**  
**RAPPORTI DISPONIBILI - AVAILABLE RATIOS**  
**R 1:1 - 1:1.5 - 1:2 - 1:3 - 1:4**

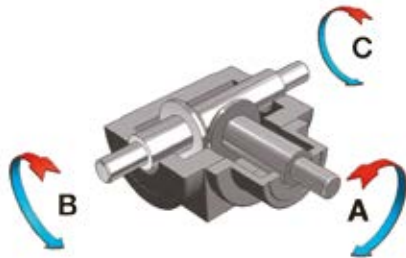

pag.  
page 18

**TIPO • TYPE 1**



pag.  
page 19

**TIPO • TYPE 2**



pag.  
page 20

**TIPO • TYPE 3**



pag.  
page 21

**TIPO • TYPE 4**



pag.  
page 22

**TIPO • TYPE 5 (scanalato - grooved UNI)**



pag.  
page 23

**TIPO • TYPE 6**



pag.  
page 24

**TIPO • TYPE 7**



pag.  
page 25

**TIPO • TYPE 8**



pag.  
page 26

**TIPO • TYPE 9**



pag.  
page 27

**TIPO • TYPE 10 (scanalato - grooved UNI)**

**FORME COSTRUTTIVE CON ALBERI O ALBERI CAVI E FLANGIA**  
**CONSTRUCTIVE FORMS WITH SHAFTS OR HOLLOW SHAFTS AND FLANGE**  
**RAPPORTI DISPONIBILI - AVAILABLE RATIOS**  
**R 1:1 - 1:1.5 - 1:2 - 1:3 - 1:4**

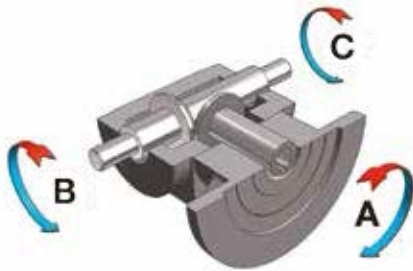

pag.  
page 28

**TIPO • TYPE 11**



pag.  
page 29

**TIPO • TYPE 12**



pag.  
page 30

**TIPO • TYPE 13**



pag.  
page 31

**TIPO • TYPE 14**

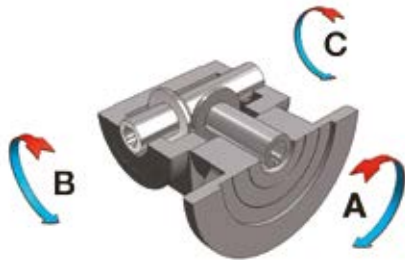

pag.  
page 32

**TIPO • TYPE 15 (scanalato - grooved UNI)**

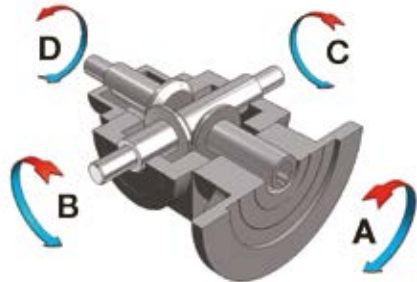

pag.  
page 33

**TIPO • TYPE 16**



pag.  
page 34

**TIPO • TYPE 17**

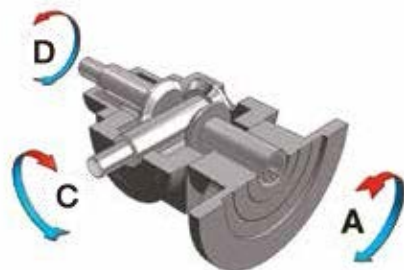

pag.  
page 35

**TIPO • TYPE 18**



pag.  
page 36

**TIPO • TYPE 19**

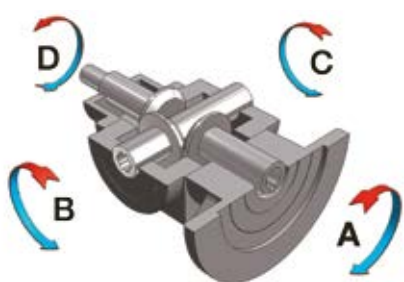

pag.  
page 37

**TIPO • TYPE 20 (scanalato - grooved UNI)**

**FORME COSTRUTTIVE A RICHIESTA  
CONSTRUCTIVE FORMS ON REQUEST**

**RAPPORTI DISPONIBILI - AVAILABLE RATIOS  
R 1:1 - 1:1.5 - 1:2 - 1:3 - 1:4**



pag. 38  
page

**TIPO • TYPE 21**



pag. 39  
page

**TIPO • TYPE 22**

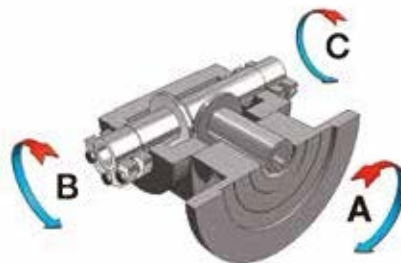

pag. 40  
page

**TIPO • TYPE 23**

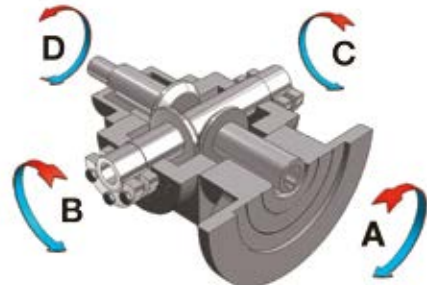

pag. 41  
page

**TIPO • TYPE 24**



pag. 42-43-44  
page

**TIPO • TYPE 25 - 26 - 27**



pag. 45-46-47  
page

**TIPO • TYPE 28 - 29 - 30**



pag. 48-49-50  
page

**TIPO • TYPE 31 - 32 - 33**

**FORME COSTRUTTIVE PARTICOLARI A RICHIESTA  
 REALIZZABILI SOLO NEI RAPPORTI DIVERSI DA R1:1  
 SPECIAL CONSTRUCTIVE FORMS ON REQUEST  
 ONLY POSSIBLE IN RATIOS OTHER THAN R1:1**

**RAPPORTI DISPONIBILI PER QUESTE FORME COSTRUTTIVE  
 AVAILABLE RATIOS FOR THESE CONSTRUCTIVE FORMS  
 R 1:1.5 - 1:2 - 1:3 - 1:4**

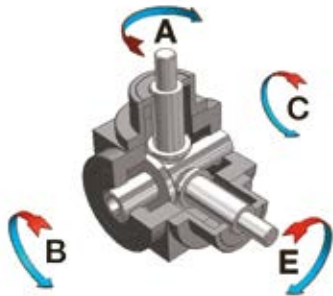

**TIPO • TYPE 34**

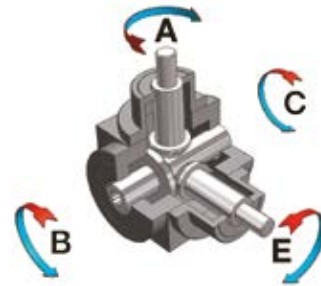

**TIPO • TYPE 35 (scanalato - grooved UNI)**

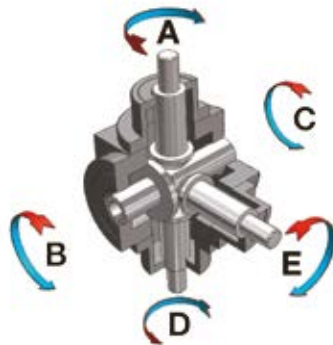

**TIPO • TYPE 36**

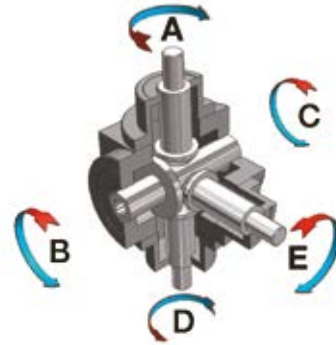

**TIPO • TYPE 37 (scanalato - grooved UNI)**

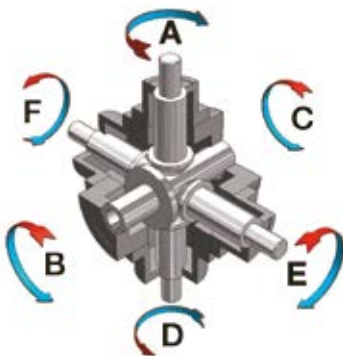

**TIPO • TYPE 38**

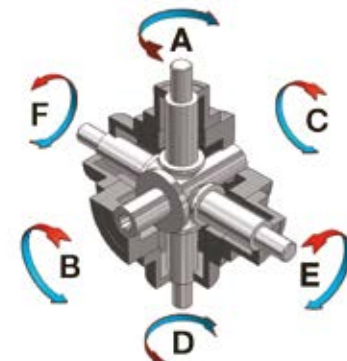

**TIPO • TYPE 39 (scanalato - grooved UNI)**

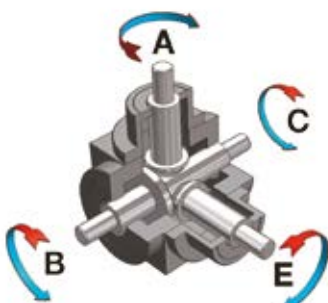

**TIPO • TYPE 40**

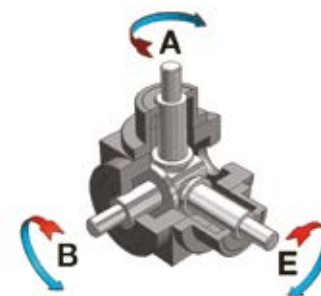

**TIPO • TYPE 41**



**FORME COSTRUTTIVE PARTICOLARI A RICHIESTA  
REALIZZABILI SOLO NEI RAPPORTI DIVERSI DA R1:1  
SPECIAL CONSTRUCTIVE FORMS ON REQUEST  
ONLY POSSIBLE IN RATIOS OTHER THAN R1:1**

**RAPPORTI DISPONIBILI PER QUESTE FORME COSTRUTTIVE  
AVAILABLE RATIOS FOR THESE CONSTRUCTIVE FORMS  
R 1:1.5 - 1:2 - 1:3 - 1:4**

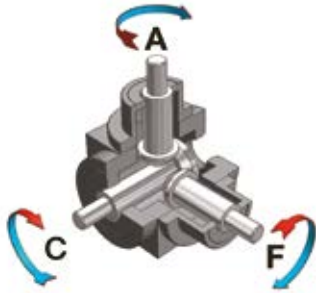

**TIPO • TYPE 42**

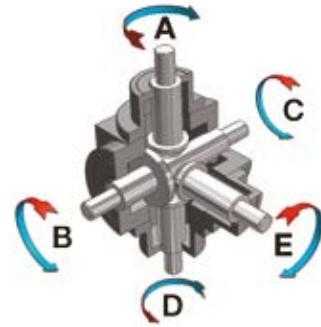

**TIPO • TYPE 43**

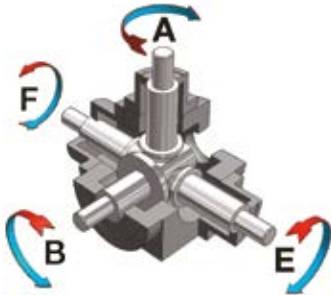

**TIPO • TYPE 44**

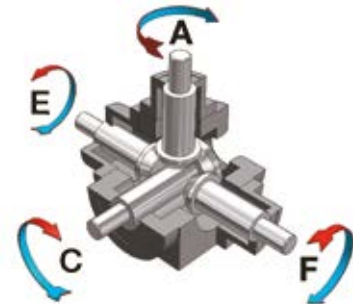

**TIPO • TYPE 45**

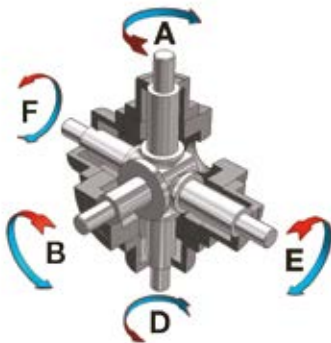

**TIPO • TYPE 46**

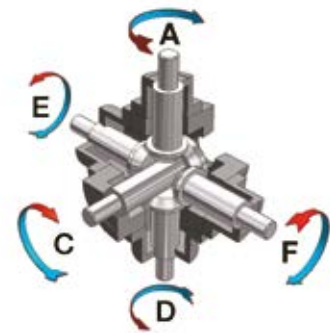

**TIPO • TYPE 47**

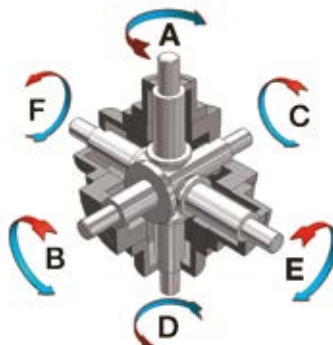

**TIPO • TYPE 48**

**FORME COSTRUTTIVE IN MOLTIPLICA A RICHIESTA**  
**CONSTRUCTIVE FORMS FORMS IN SPEED MULTIPLIER ON REQUEST**  
**RAPPORTI DISPONIBILI PER QUESTE FORME COSTRUTTIVE**  
**AVAILABLE RATIOS FOR THESE CONSTRUCTIVE FORMS**  
**R1.5:1 - 2:1 - 3:1 - 4:1**

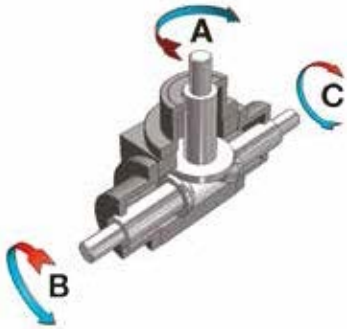

**TIPO • TYPE 49**

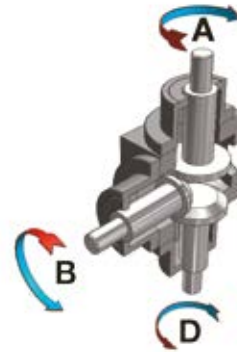

**TIPO • TYPE 50 (\*)**

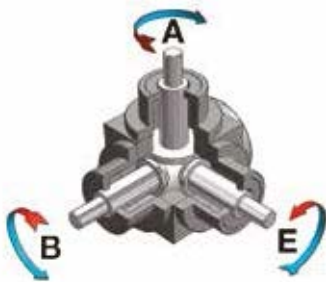

**TIPO • TYPE 51**

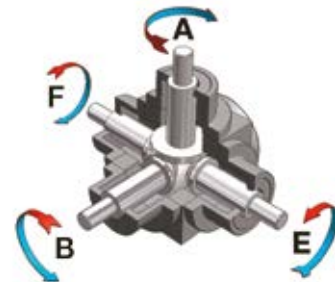

**TIPO • TYPE 52**

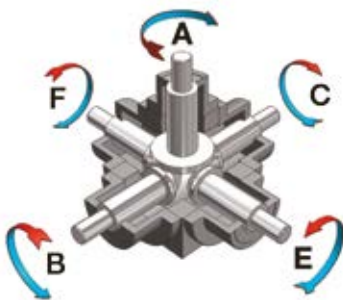

**TIPO • TYPE 53**

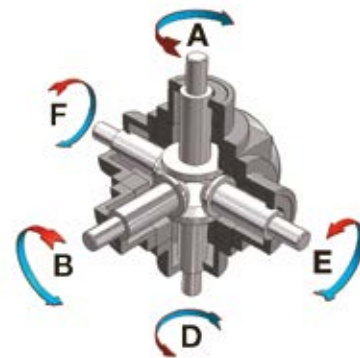

**TIPO • TYPE 54**

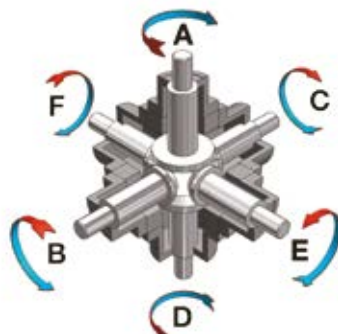

**TIPO 55**

**(\*)** Per questa tipologia che rappresentiamo per completezza fare riferimento al tipo 28-29-30 nei rapporti in riduzione e utilizzare come albero di ingresso "B" o "C".  
 For this type, which is shown for completeness, refer to type 28-29-30 in reduction ratios and use "B" or "C" as input shaft.