

PC/ATW 090/105

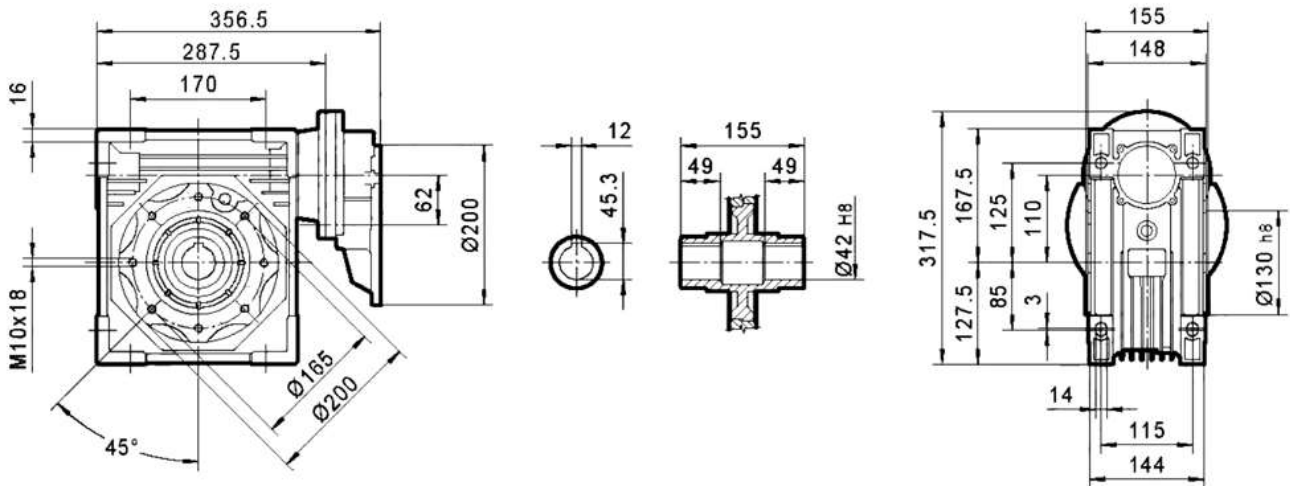

PC/ATW 090/110

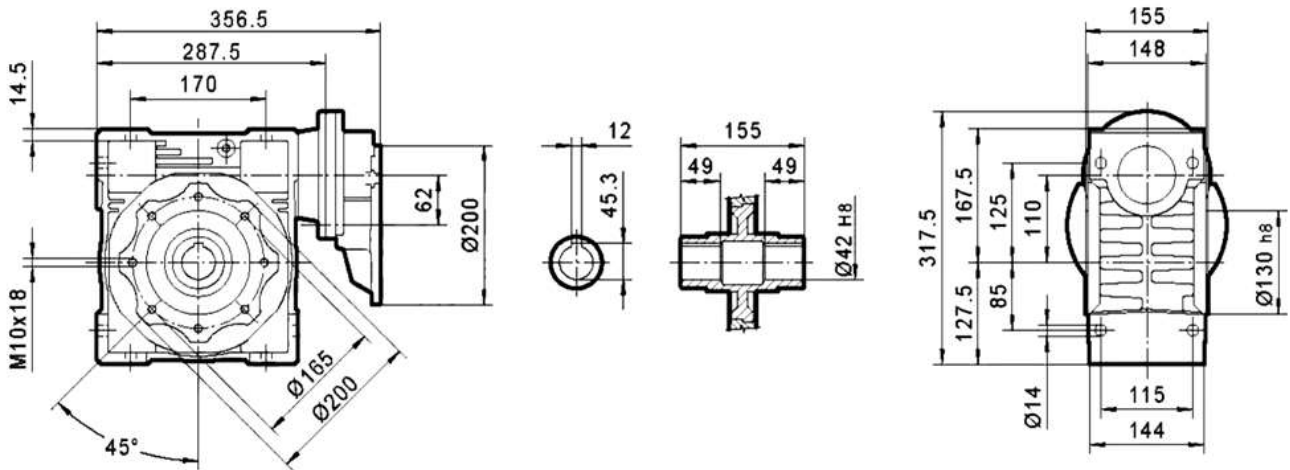

PC/ATW 090/130

