

KAT 35

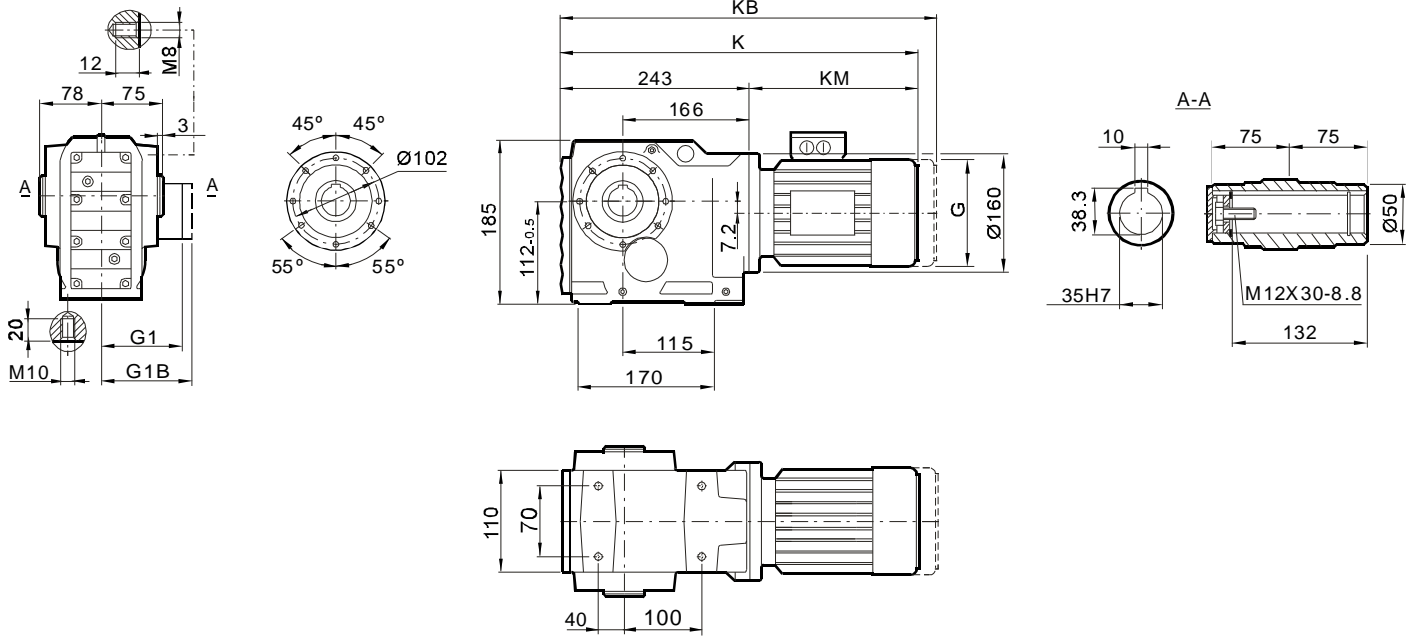

Motor frame

Dimensions	63	71	80	90	100M	100L
G	132	145	145	197	197	197
G1	105	122	122	154	166	166
G1B	105	127	127	161	166	166
K	428	442	492	512	562	592
KB	483	506	556	597	647	677
KM	185	199	249	269	319	349

KAT 35 F

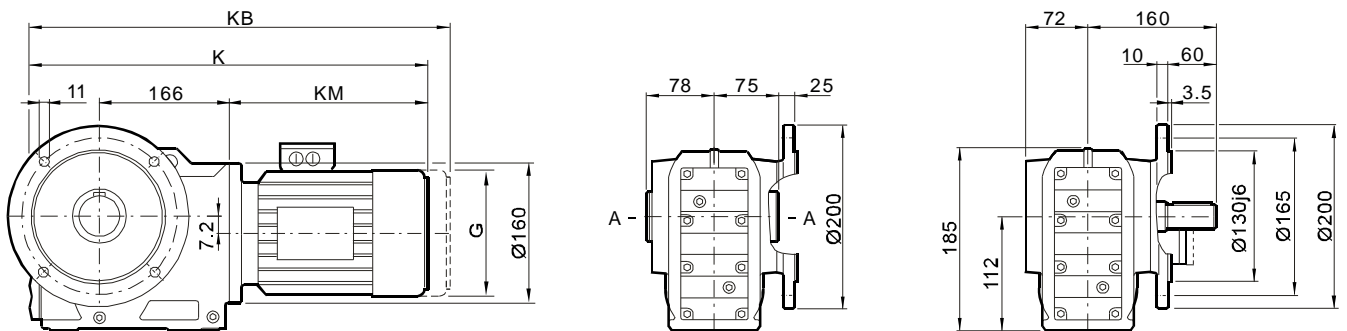

TORQUE ARM

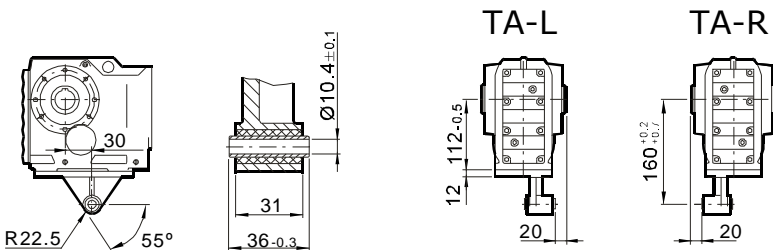

SINGLE LOW SPEED SHAFTS

